



IDENTIFICATION OF HOTSPOT OF AQUIFER CONTAMINATION USING GEOPHYSICAL INVESTIGATION

|Jahangeer¹| Pankaj Kumar Gupta¹| Vikram Kumar¹| Shashi Ranjan¹| and | Shaktibala² |

¹. Department of Hydrology | Indian Institute of Technology Roorkee | Uttarakhand 247667 | India |

². Department of Civil Engineering | SBCET Jaipur | Rajasthan – 302013 | India |

|Received | 02 August 2016|

|Accepted | 08 August 2016|

|Published 16 August 2016 |

ABSTRACT

Background: Groundwater contamination may be localized or spread over a large area, depending on the nature and source of the pollutant and on the nature of the groundwater system. A problem of growing concern is the cumulative impact of contamination of a regional aquifer from nonpoint sources and point sources. For the regional level investigation, geoelectrical methods are emerging advance technological supports to identify the contamination hotspot in groundwater. The geoelectrical methods integrated with the sediments chemistry and hydrogeological conditions can be used to investigate groundwater and vadose zone contamination investigation. **Objective:** The aim of this study is to investigate the aquifer contamination hotspot using advance geophysical techniques. **Materials and Methods:** In this study we have performed three level of sounding in study area at different geophysical level. The resistivity meter was installed at different AB/2 values to measure the resistivity of the geological formation using different sounding configuration. Parallel to sounding, the hydro-geological parameters were investigated and plotted in same scale. The measured resistivity of all three sounding was applied to hydro-geological formation to prepare the vulnerability maps. **Results:** The results of this study indicated the different level of the contamination in study aquifer and present in the vulnerability maps. The extension of the contamination was also indicated in the prepared vulnerability map to identify the area or zone of contamination hotspots. **Conclusions:** The investigation gives the understanding of the aquifer configuration at regional levels as well as the hotspots of contamination. On the basis of aquifer configuration and contamination level, the management's strategy of the groundwater development and managements becomes the cost effective and more efficient technological supports to sustainable developments of water resources.

Keywords: Groundwater, Electrical Sounding, Aquifers, vulnerability Map, Sustainable Developments.

1. INTRODUCTION

Access to clean water is a human right and a basic requirement for economic development. The provision of clean drinking water has been given priority in the Constitution of India, with Article 47 conferring the duty of providing clean drinking water and improving public health standards to the State.

On one hand the pressures of development is changing the distribution of water in the country, access to adequate water has been cited as the primary factor responsible for limiting development. The average availability of water is reducing steadily with the growing population and it is estimated that by 2020 India will become a water stressed nation. Groundwater is the major source of water in our country with 85% of the population dependent on it.

While accessing drinking water continues to be a problem, assuring that it is safe is a challenge by itself. Water quality problems are caused by pollution and over-exploitation. The rapid pace of industrialization and greater emphasis on agricultural growth combined with financial and technological constraints and non-enforcement of laws have led to generation of large quantities of waste and pollution. Salinity in ground water is prevalent mainly in the arid and semi-arid regions of Rajasthan, Haryana, Punjab and Gujarat. About 2 lakh sq.km area has been estimated to be affected by saline water of Electrical Conductivity in excess of 4000 $\mu\text{S}/\text{cm}$. There are several places in Rajasthan and southern Haryana where EC values of ground water is greater than 10000 $\mu\text{S}/\text{cm}$ making water non potable [1]. In some of the metro-cities like Agra and Meerut, the salinity is increasing at a fast rate. This can be attributed to percolation of accumulated salts in intense irrigated areas and industrial activities. Groundwater quality with respect to critical chemical parameters such as Chloride, Total dissolved solids (TDS), Nitrate-N, Fluoride, Total and Faecal Coliforms and heavy metals are summarized. Groundwater quality with respect to critical metals such as Iron, Chromium, Copper, Manganese and Zinc and their compliance/violations against drinking water standards in both the seasons.

As safe and effective use of the subsurface environment is a major challenge facing our society, there is a great need to improve our understanding of the shallow subsurface and the groundwater systems. As the subsurface is impossible to 'observe' directly, methods are needed to reveal its physical and hydrological properties, in addition to the hydro-chemical

characteristics of fluids stored and flowing through it. Traditional borehole-based sampling is often limited because of the localized knowledge often derived from such measurements and the disturbance induced to samples. As in the oil and mining industry, geophysical methods may offer a means of addressing this problem, by providing a spatially extensive, non-invasive means of investigating the subsurface. Recently, increased attention has been given to the use of geophysical methods to derive parameters and state variables characterizing especially surface near groundwater systems and soils [2,3,4].

Geophysical methods continue to show great promise for use in groundwater. Geophysics can be defined several ways. In the broadest sense, geophysics is the application of physical principles to studies of the Earth [5]. This general definition of geophysics encompasses a wide range of disciplines, such as hydrology, meteorology, physical oceanography, seismology, tectonophysics, etc. The geophysical methods employed to obtain subsurface information from surface-based measurements include resistivity, electromagnetic induction, ground-penetrating radar, magnetometry, self-potential, seismic, gravity, radioactivity, nuclear magnetic resonance, induced polarization, etc.

Geophysical methods can be classified as passive or active. There is no artificial application of energy with passive geophysical methods. On the other hand, active geophysical methods do require the artificial application of some form of energy. The three geophysical methods predominantly used for agricultural purposes are resistivity, electromagnetic induction, and ground-penetrating radar.

Resistivity methods measure the electrical resistivity, or its inverse, electrical conductivity, for a bulk volume of soil directly beneath the surface. Resistivity methods basically gather data on the subsurface electric field produced by the artificial application of electric current into the ground. With the conventional resistivity method, an electrical current is supplied between two metal electrode stakes partially inserted at the ground surface, while voltage is concurrently measured between a separate pair of metal electrode stakes also inserted at the surface. The current, voltage, electrode spacing, and electrode configuration are then used to calculate a bulk soil electrical resistivity (or conductivity) value [1,2].

Self-potential methods collect information on a naturally occurring electric field associated with non-artificial electric currents moving through the ground. Unlike resistivity methods, no electric power source is required. Naturally occurring electric potential gradients can arise a number of different ways, including the subsurface flow of water containing dissolved ions, spatial concentration differences of dissolved ions present in subsurface waters, and electrochemical interactions between mineral ore bodies and dissolved ions in subsurface waters. Self-potential methods are fairly simple operationally. All that is required to obtain information on a natural electric field below ground is the voltage measurement between two non-polarizing electrodes placed or inserted at the ground surface.

Soil-water salinity refers to the presence of major dissolved inorganic solutes in the soil aqueous phase, which consist of soluble and readily dissolvable salts including charged species (e.g., Na⁺, K⁺, Mg²⁺, Ca²⁺, Cl⁻, HCO₃⁻, NO₃⁻, SO₄²⁻, and CO₃⁻, non-ionic solutes, and ions that combine to form ion pairs. Dissolved electrodes change the electrical characteristic of the measurements and at regional level the comparative analysis gives the picture of the contamination in groundwater. A quantity used as an indicator of the exchangeable sodium percentage (ESP), which is the percentage of the soil cation exchange capacity occupied by sodium ions (Na⁺). Both SAR and ESP are used to gauge soil sodicity that reflects not only the amount of sodium present but also its impact on plant growth. The value of SAR is commonly determined from the calcium ion (Ca²⁺), magnesium ion (Mg²⁺), and sodium ion (Na⁺) concentrations in a solution extracted from a saturated soil paste. As the resistivity decreases, the salinity and ions in the water increases. Therefore, the dispersion and diffusion of contamination limited to are area where originated. Similarly the resistivity in bed rock decreases indicates the increasing trends of clay layers; again the clay limits the contamination dispersion and diffusion.

2. MATERIALS AND METHODS

2.1 Self-potential method:

At constant potential, the current is inversely proportional to the solution's resistance. The measured conductance is a consequence of the solution's salt concentration and the electrode geometry whose effects are embodied in a cell constant. The electrical conductance is a reciprocal of the resistance as shown in Equation (1):

$$ECT = k/RT \quad (1)$$

Where ECT is the electrical conductivity of the solution in dS m⁻¹ at temperature T (°C), k is the cell constant, and RT is the measured resistance at temperature T. Electrolytic conductivity increases at a rate of approximately 1.9 percent per degree centigrade increase in temperature. Customarily, EC is expressed at a reference temperature of 25°C for purposes of comparison. The EC measured at a particular temperature T (°C), ECT, can be adjusted to a reference EC at 25°C, EC₂₅, using the below equations:

$$EC_{25} = f_T \times ECT \tag{2}$$

where f_T is a temperature conversion factor. Approximations for the temperature conversion factor are available in polynomial form [6, 7, 8].

The SP method measures natural potential found within the earth. Measurements, usually in milli-volts, are obtained from the recording potentiometer connected to two like electrodes. One electrode is lowered in an uncased well and the other is connected to the ground surface as in Figure 1. The potential are primarily produces by the electrochemical cell formed by the electrical conductivities differences of the drilling mud and groundwater where the boundaries of permeable zones intersect a borehole. In some instance electro kinetic effects of the fluids moving through permeable formation are also responsible for SP.

The potential depends on the ration of the salinities of the drilling mud to the formation water. SP resulting from electrochemical potential can be expressed by:

$$SP = -(64.3 + 0.239T) \log \rho_f / \rho_w \tag{3}$$

Where the ρ_f is the drilling fluid resistivity in ohm-m, ρ_w is the groundwater resistivity. It should be noted that the resistivity of the groundwater is the reciprocal of its specific conductivities. The relation is the form:

$$\rho_w = 104 / EC. \tag{4}$$

Where ρ_w is the the groundwater resistivity in ohm-m and the EC is specific conductance in $\mu S/cm$.

The TDS (total dissolved solids) is calculated by the following relation:

$$TDS = 0.627 * EC \tag{5}$$

Where the TDS is ppm and mg/l. and EC is $\mu S/cm$. The resistivity of the groundwater depends on ionic concentration and ionic mobility of the salt solution. The ion mobility of a sodium chloride solution is several times that of a comparable calcium carbonate solution.

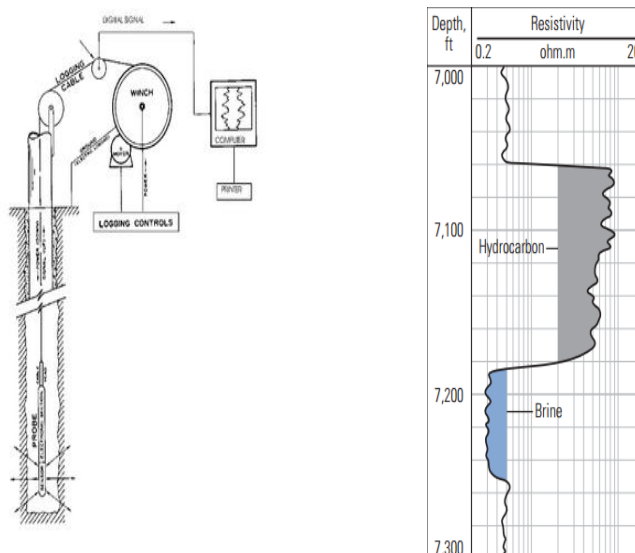

Figure 1: (a) the figure shows the method of the measurement of SP. (b) Resistivity Curve of SP results.

A contaminant plume in the ground is typically a thermodynamic system out of equilibrium. There are several sources of self-potential signals. They are (1) diffusion potentials associated with concentration gradients, (2) redox potentials associated with a gradient in the electro activity of the electrons, and (3) streaming potential associated with ground water flow. Naudet et al, (2003) were the first to investigate the quantitative relationship between the self-potential signals and geochemical parameters prevailing in a contaminant plume [9, 10].

Weigel, (1989) has realized a monitoring of the self-potential signals with a network of 256 electrodes in the purpose to delineate a contaminant plume [11]. He observed a correlation between the self-potential signals (approximately -40 mV) and the extent of the contaminant plume. The contamination comes from dissolved salts from a repository and the electrical potential is observed to be small in areas where the salinity is high. Similarly, Hamman et al, (1997) have performed a self-potential survey in the vicinity of a landfill in Switzerland [12]. Self-potential anomalies observed were associated with contaminant plumes with negative anomalies of -30 mV and positive anomalies of +50 mV to +75 mV for other type of wastes. Sauck et al, (1998) have obtained positive self-potential signals delineating an LNAPL (Light Non-Aqueous Phase Liquid) contaminant plume in the ground [13].

2.2 Resistivity method:

Electrical resistivity methods involve the measurement of the resistance to current flow across four electrodes inserted in a line on the soil surface at a specified distance between the electrodes (Figure 2). The resistance to current flow is measured between a pair of inner electrodes while electrical current is caused to flow through the soil between a pair of outer electrodes. Although two electrodes (i.e., a single current electrode and a single potential electrode) can also be used this configuration is highly unstable, and the introduction of four electrodes helped to stabilize the resistance measurement. According to Ohm’s Law, the measured resistance is directly proportional to the voltage (V) and inversely proportional to the electrical current (i):

$$R=V/I \tag{6}$$

Where resistance (R) is defined as one ohm (ω) of resistance that allows a current of one ampere to flow when one volt of electromotive force is applied.

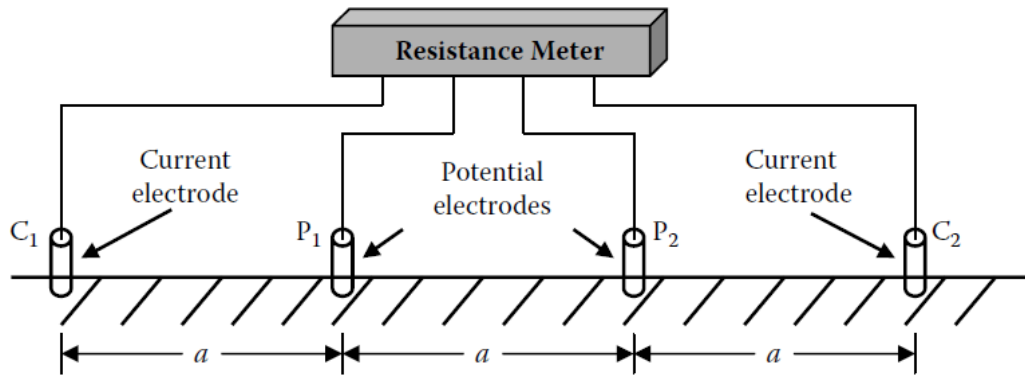

Figure 2: Arrangement of Electrodes for resistivity measurement (Wenner arrangement).

The conductance (C, ω^{-1} or Siemens, S) is the inverse of resistance, and the ECa (dS m⁻¹) is the inverse of the resistivity:

$$EC=1/\rho=1/R(1/a) =C(1/a) \tag{7}$$

When the four electrodes are equidistantly spaced in a straight line at the soil surface, the electrode configuration is referred to as the Wenner array (Figure 2). The resistivity measured with the Wenner array is shown in Equation 8:

$$\rho = 2\pi a\Delta V/i=2\pi aR \tag{8}$$

And the measured EC is as shown in Equation (9):

$$EC= 1/2\pi aR \tag{9}$$

Where a is the inter electrode spacing (m).

There are a variety of electrode configurations, called electrode arrays, most of which are linear, with the Wenner, Schlumberger, and dipole-dipole arrays the ones employed the majority of the time. The traditional Schlumberger array is symmetric, and as shown in Figure 3, typically has the current electrodes on the outside of the array and the potential electrodes placed within the arrays interior. The spacing between the current electrodes is by a large factor greater than the spacing between the potential electrodes. Being able in practice to move the outer current electrodes further apart, while potential electrode positions are kept constant, makes the Schlumberger array one of the best available for determining variations of resistivity with depth.

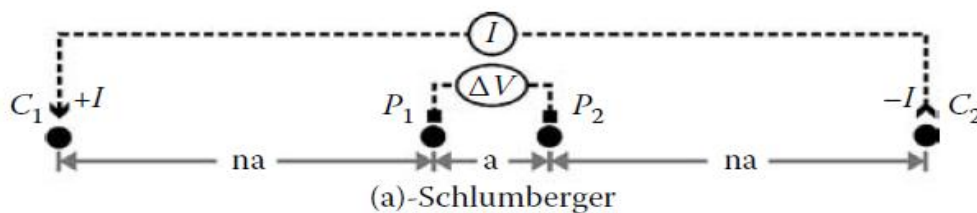

Figure3: Arrangement of Electrodes for resistivity measurement (Schlumberger arrangement).

The Schlumberger array, the apparent resistivity is calculated as follows:

$$\rho = \Delta V / I \pi(n)(n+1)a \tag{10}$$

Where a is a distance value, and n is a factor by which that distance is multiplied.

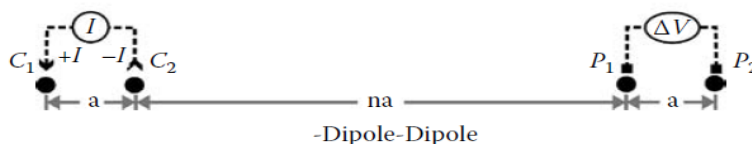

Figure 4: The figure presents the dipole-Dipole Arrangement of Electrodes for resistivity measurement.

The dipole-dipole array (Figure 4) is normally configured to have a relatively large separation between the pair of current electrodes on one side of the array and the pair of potential electrodes on the other side of the array. The dipole-dipole array is employed both for mapping lateral changes in ρa and for assessing the variation of resistivity with depth. When using this array for areal mapping of ρa , the spacing between electrodes remains constant as the array is moved from one location to another, but for measuring resistivity changes with depth, the array midpoint stays at the same location and the current electrode pair and the potential electrode pair are moved further apart.

The apparent resistivity for the dipole-dipole array (Figure 4) is expressed as follows:

$$\rho = \Delta V / I \pi(n)(n+1)(n+2)a \tag{11}$$

Organic and inorganic contaminants can be the origin of groundwater pollution within the surrounding area of waste deposits and abandoned industrial sites. Geophysical mapping strategies of contaminant plumes depend on the contaminant-groundwater interaction: inorganic contaminants dissolve, whereas organic contaminants are in general not dissolvable and so do not affect the physical properties of the groundwater. Abandoned industrial sites are mainly characterized by remnants of production facilities (pipelines, tanks, cables, building foundations) and contaminated soil. If geoelectrical or electromagnetic measurements are possible without perturbation by power lines or metallic objects, resistivity mapping can show an overview of the previous installations of that place. Soil contamination, e.g. through mineral oil or slags, is common on previous industrial sites. Considered here are only the contaminations in the vadose zone above the groundwater table, whereas the groundwater contaminations will be treated in the next paragraph. Hydrocarbons such as diesel fuel normally have low conductivities. However, long term hydrocarbon pollution in the vadose zone can undergo biodegradation processes under aerobic conditions resulting in high conductivities or low resistivities due to an increase of cation exchange capacity [14].

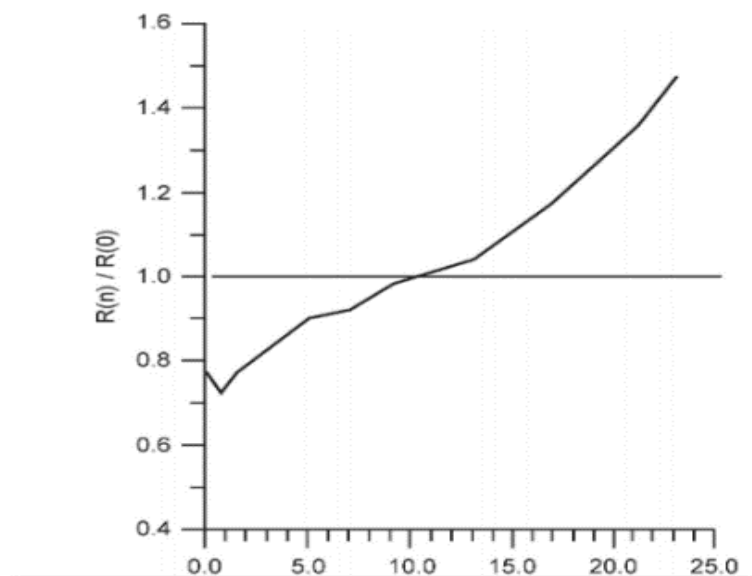

Figure 5: The graph presents the influence of hydrocarbon concentration in unsaturated sand on resistivity, $R(n)$ resistivity measured, $R(0)$ resistivity at zero hydrocarbon concentration.

This can explain the sometimes complicated pattern of resistivity anomalies connected to hydrocarbon pollutions. Grinat et al, (2001) observed very high resistivities in the vadose zone above an up to 0.85 m thick kerosene layer on the groundwater table (Figure. 5) [15].

Since hydrocarbons have in general a lower electrical conductivity and a lower dielectric permittivity than water, a blanket of LNAPL with sufficient thickness floating on the groundwater table should be detectable through resistivity and methods. An example is shown by Benson et al., (1997) where a gasoline spill was mapped with 2-D resistivity as a resistive zone on the groundwater table and in the vadose zone (Figure 6) [16]. However, the moderate resistivity increase was only detectable in a low resistivity environment. Reference profiles outside the contaminated area are essential for the interpretation of the measurements.

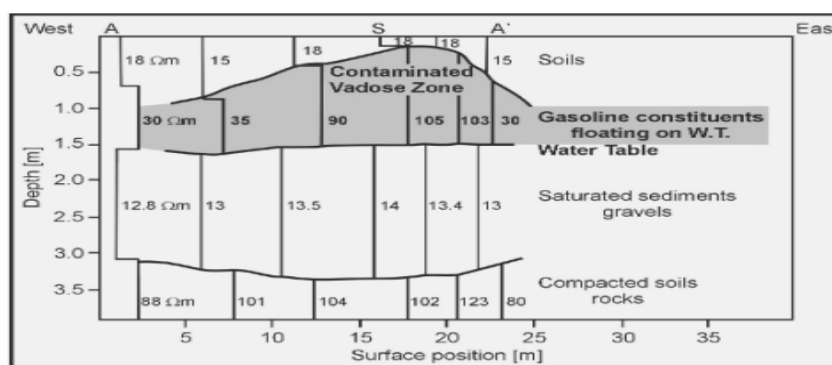

Figure 6: The figure presents the resistivity profile covering a gasoline spill (top) and undisturbed reference profile (bottom).

2.3 Vulnerability maps:

Vulnerability of an aquifer is defined as the sensitivity of groundwater quality to an imposed contaminant load, which is determined by the intrinsic characteristics of the aquifer [17]. This is different to the expression pollution risk which depends on vulnerability as well as on the existence of pollutants entering the subsurface. Groundwater protection requires information on groundwater vulnerability. Maps showing the lateral distribution of well protected and poorly protected aquifers are therefore essential for spatial development. These maps are called vulnerability maps.

The relation between soil parameters like clay content, cation exchange capacity, and hydraulic conductivity to electrical resistivity enables a vulnerability assessment based on geoelectrical or SP measurements. Results of these measurements can be used as an estimate of clay content and hydraulic conductivity of the soil, or to interpolate vulnerability quantified by rating systems.

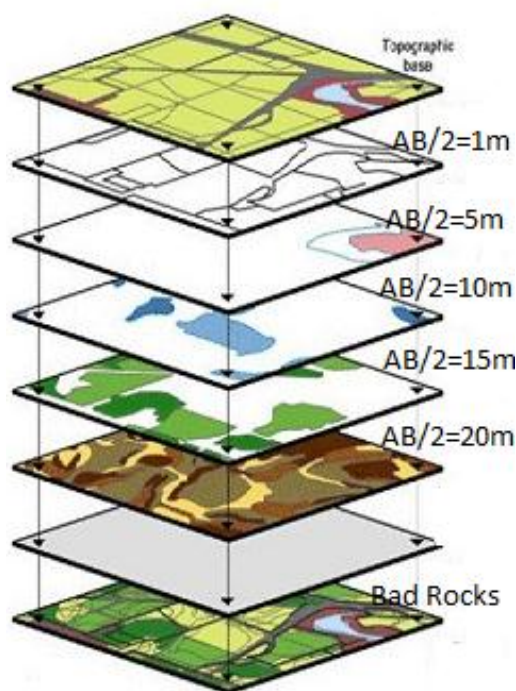

Figure 7: Vulnerability map prepared on the basis of the geophysical sounding having the different values of AB/2 of the study area as well as hydro-geological information of an aquifer.

3. RESULTS

The three sounding data was collected from the surface sounding with Schlumberger methods. The data set obtained from the field experiment is plotted. The Figure 8 showed the resistivity curve I: AB/2 (m) Vs resistivity (ohm.m) of first sounding and similarly all three are plotted in Figure 9 and 10. A combination of all sounding is plotted at X,Y, Z, axis with AB/2 in meter in Figure. 11, which show the resistivity profile. The Vulnerability map of an aquifer consisting all three sounding is plotted to assist the water vulnerabilities in Figure 12.

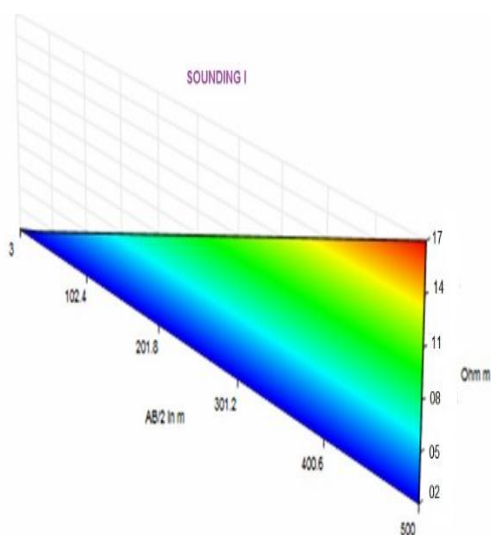

Figure 8: Field investigated Resistivity Curve I based on the different value of AB/2 (m) Vs measured Resistivity (Ohm.m) during sounding I.

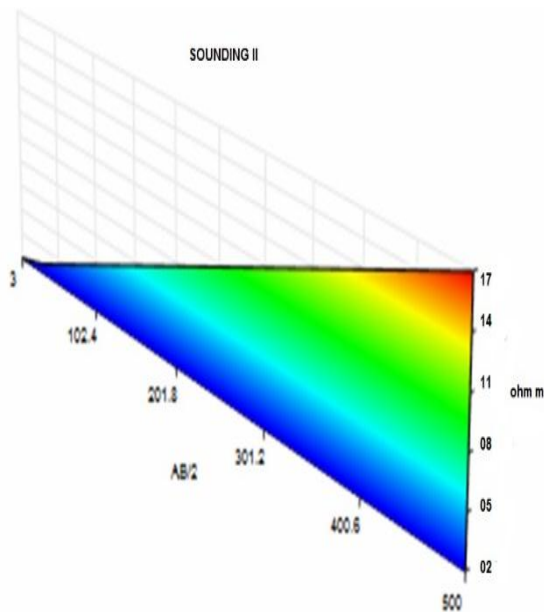

Figure 9: Field investigated Resistivity Curve I based on the different value of AB/2 (m) Vs measured Resistivity (Ohm.m) during sounding II.

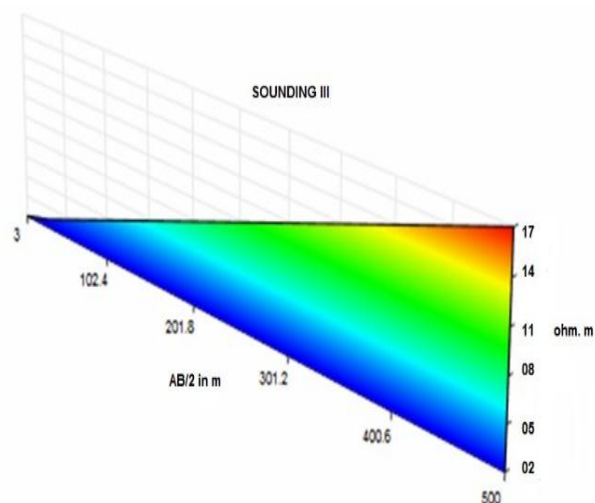

Figure 10: Field investigated Resistivity Curve I based on different value of the AB/2 (m) Vs measured Resistivity (Ohm.m) during sounding III.

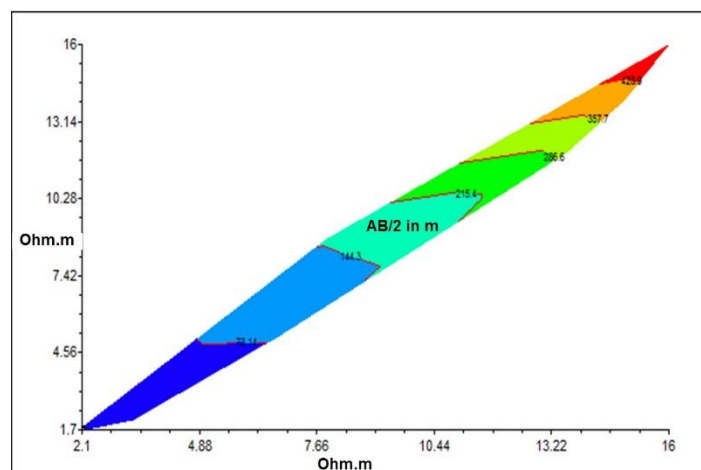

Figure 11: A curve representing the combined effects of all three sounding, where measured resistivity (Ohm.m) plotted with different value of the AB/2 (m).

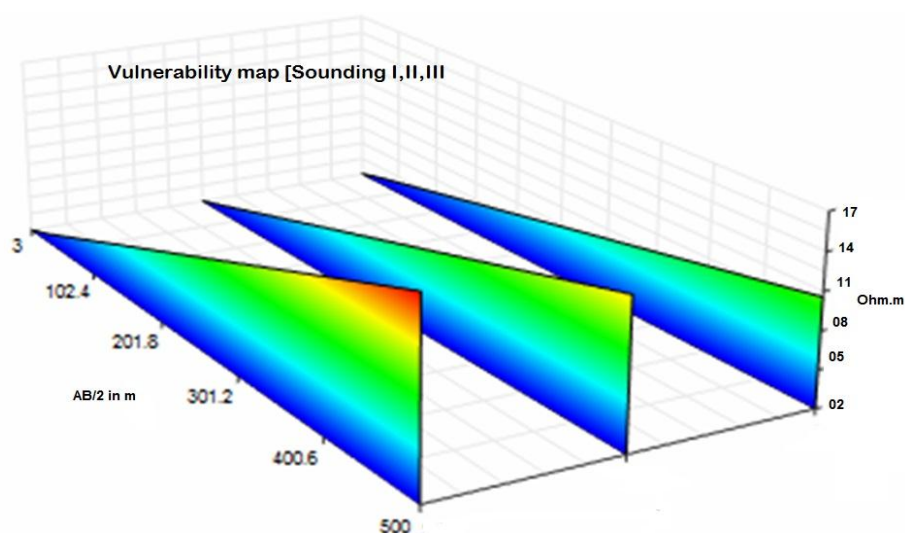

Figure 12: Vulnerability map prepared on the basis of the geophysical sounding having the different values of AB/2 versus measured values of resistivity (Ohm.m) of all three sounding together.

4. DISCUSSION

Clearly, self-potential and geo-electrical measurements and monitoring can bring useful information about vadose zone processes. For example, spatial variations of soil lithology, such as clay content, could be investigated with self-potential mapping. The conclusions reached are the following (1) the self-potential method can be used to delineate a contaminant plume rich in organic matter, the strength of the anomalies can reach several hundreds of millivolts; (2) the contaminant plume behaves as a natural geo battery and the electrical signals are proportional to the variations of the redox potential; (3) the self-potential signals can be analyzed quantitatively with a minimum of in situ measurements of the redox potential to calibrate the linear relationship observed between the self-potential signals and the in situ redox potentials. Bacteria play likely a critical role in the process of the geo battery because they participate directly to the transfer of the electrons at the edge of the contaminant plumes where most of the bio-mass is located and where there are sharp variations in the gradient of the redox potential.

Hammann et al, (1997) have been used these integral relationships to formulate the inverse problem to locate the source of these signals inside a geological structure. This is called self-potential tomography. In the quasi-static limit of the Maxwell equations, self-potential tomography can be performed with algorithms developed for electroencephalography due to the similarity between these two methods. These improvements imply a bright future for the self-potential method because of the high number of applications in hydrogeology that can be foreseen, its good signal-to-noise ratio, and a good understanding of the underlying physics. The Implementation of geophysical technologies for the verification and monitoring of these structures will useful techniques in groundwater contamination plume determination. For example, the application of electrical resistivity to leak detection from geo-membrane liners has advanced with the installation of geophysical monitoring equipment beneath landfills. The geophysical investigations are also important for the management of the reactive barriers. Using the assessment map the site for the permeable barrier can determinate. The permeable reactive barrier is an engineered structure designed to remediate contaminated groundwater flowing through it. The reactive material of the barrier participates in a redox reaction with the contaminant, resulting in the conversion of the contaminant into inorganic, non-toxic compounds.

Vulnerability maps based on geoelectrical or SP measurements can give an overview of the groundwater protection of the area. Small scale and more detailed measurements can be done on demand, e.g. within the surrounding of well fields. Thus, more studies at the laboratory and the field scale are needed to better understand the influence of environmental changes processes on geophysical signatures and to further this new discipline of hydro geophysics.

5. CONCLUSION

Geo-electrical methods are emerging advance technological supports to investigate the contamination in groundwater. This study is used to identify the aquifer contamination hotspot using geophysical techniques based on resistivity analysis. The results of this study indicated the different level of the contamination in study aquifer and present in the vulnerability maps. The extension of the contamination was also indicated in the prepared vulnerability map to identify the area or zone of contamination hotspots. The investigation gives the understanding of the aquifer configuration at regional levels as well as the hotspots of contamination and On the basis of aquifer configuration & contamination level, the management's strategy of the groundwater development and managements becomes the cost effective and more efficient technological supports to sustainable developments of water resources.

6. REFERENCES:

1. Israil, M., Mufid al-Hadithi and Singhal, D. C. Application of a resistivity survey and geographical information system (GIS) analysis for hydrogeological zoning of a piedmont area, Himalaya foothill region, India. *Hydrogeology journal*, 2006.14(5): 753–759. Available on: <http://link.springer.com/article/10.1007/s10040-005-0483-0>
2. Rubin, Y., and S.S. Hubbard (eds), 2005. Hydrogeophysics, Springer, The Netherlands. <http://link.springer.com/book/10.1007%2F1-4020-3102-5>.
3. Vereecken H., U. Yaramanci, and A. Kemna. Non-invasive methods in hydrology. Special issue. *Journal of Hydrology*, 2002. (267): 125–299. doi:10.1016/S0022-1694(02)00346-3
4. Vereecken H., S. Hubbard, A. Binley, and T. Ferre . Hydrogeophysics: An introduction from guest editors. *Vadose Zone Journal*, 2004. (3): 1060–1062. doi: 10.2113/3.4.1060 Published on November 2004, First Published on November 29, 2004
5. Sheriff, R. E. Encyclopedic Dictionary of Applied Geophysics, 4th edition. *Society of Exploration Geophysics*. Tulsa, OK.2002. Available on: doi:10.1190/1.9781560802969
6. Rhoades, J.D., Chanduvi, F., and Lesch, S. Soil salinity assessment: Methods and interpretation of electrical conductivity measurements, FAO Irrigation and Drainage Paper #57, *Food and Agriculture Organization of the United Nations*, Rome, Italy,1999a pp. 1–150.
7. Stogryn, A. Equations for calculating the dielectric constant of saline water, *IEEE Trans. Microwave Theory Technology*, 1971.19(8): 733–736. Available on: doi: 10.1109/TMTT.1971.1127617
8. Robinson, D.A., S.B. Jones, J.W. Wraith, D. Or, and S.P. Friedman. A review of advances in dielectric and electrical conductivity measurement in soils using time domain reflectometry, *Vadose Zone Journal*, 2003 (2):444–475. Available on: doi:10.2136/vzj2003.4440
9. Naudet, V., A. Revil, J.-Y. Bottero, and P. B'egassat. Relationship between self-potential (SP) signals and redox conditions in contaminated groundwater, *Geophys. Res. Lett.*, 2003. 30 (21); 2091. Available on: doi: 10.1029/2003GL018096.
10. Naudet, V., A. Revil, E. Rizzo, J.-Y. Bottero, and P. B'egassat. Groundwater redox conditions and conductivity in a contaminant plume from geoelectrical investigations, *Hydrology Earth System Sciences*, 2004. 8 (1): 8–22. Available on: <http://www.hydrol-earth-syst-sci.net/8/8/2004/>
11. Weigel, M. Self-potential surveys on waste dumps, in Theory and Practice in Detection of subsurface Flow Phenomena, Lecture Notes in Earth Sciences, vol. 27, G.-P. Merkle et al. (Eds.), Detection of Subsurface Flow Phenomena, Springer, Heidelberg, Germany, 1989.pp. 109–120.
12. Hammann, M., H.R. Maurer, A.G. Green, and H. Horstmeyer. Self-potential image reconstruction: Capabilities and limitations, *Journal of Environ. Eng. Geophysics*, 1997. (2): 21–35. Available on: doi: 10.4133/JEEG2.1.21
13. Sauck, W.A., E.A. Atekwana, and M.S. Nash. High conductivities associated with an Inapl plume imaged by integrated geophysical techniques, *Journal of Environ. Eng. Geophysics*, 1998. 2(3): 203–212. Available on: [Print ISSN: 1083-1363](http://dx.doi.org/10.1083/1363)
14. Godio, A., Naldi, M., 2003, Two-dimensional electrical imaging for detection of hydrocarbon contaminants: Near Surface, *Geophysics*, 2003. (1): 131-137. Available on: doi: 10.3997/1873-0604.2003003
15. Grinat M. Geoelektrische Messungen über einem Kerosinschaden auf dem Flughafen Schwerin-Parchim. Proc 7. DGG-Seminar "Ingenieur- und Umweltgeophysik", Mitteilungen der Deutschen Geophysikalischen Gesellschaft, Sonderband, 2001.(II/02):43-47
16. Benson AK, Payne KL, Stubben MA. Mapping groundwater contamination using DC resistivity and VLF geophysical methods - a case study. *Geophysics*, 1997. (62):80-86. Available on: <http://dx.doi.org/10.1190/1.1444148>
17. Lobo-Ferreira JP. The European Union experience on groundwater vulnerability assessment and mapping. *COASTIN A Coastal Policy Research Newsletter*, 1999. (1):8-10. Available on: <http://www.inec.pt/hidraulica-ambiente/pt/projectos/detalhe/coastin-measuring-monitoring-and-managing-sustainability-the-coastal-dimension>

Cite this article: Jahangeer, Pankaj Kumar Gupta, Vikram Kumar, Shashi Ranjan and Shaktibala. IDENTIFICATION OF HOTSPOT OF AQUIFER CONTAMINATION USING GEOPHYSICAL INVESTIGATION). *Am. J. innov. res. appl. sci.* 2016; 2(9): 381-390.

This is an Open Access article distributed in accordance with the Creative Commons Attribution Non Commercial (CC BY-NC 4.0) license, which permits others to distribute, remix, adapt, build upon this work non-commercially, and license their derivative works on different terms, provided the original work is properly cited and the use is non-commercial. See: <http://creativecommons.org/licenses/by-nc/4.0/>.